



# CommBox Interactive Classic User Manual

# Foreword

Thank you for purchasing CommBox Interactive Classic.

Please read all the accompanying documents carefully before installing and using this product. Failure to operate the product in accordance with this Manual, or operating it wrongly for whatever reason, may result in electric shock, fire or other hazards.

Pictures provided in this Manual are for reference only. In case any picture deviates from the actual product, the latter shall take precedence.

We reserve the right to improve and modify this Manual without further notice.

Please retain this Manual for future reference.

Do not attempt to disassemble the product.

If the product does not work, please contact us.

# Contents

<b>1</b>	<b>Safety Warnings</b>	<b>4</b>
<b>2</b>	<b>Precautions</b>	<b>4</b>
<b>3</b>	<b>Product Features</b>	<b>5</b>
<b>4</b>	<b>Accessories</b>	<b>6</b>
<b>5</b>	<b>Wall Mount</b>	<b>6</b>
<b>6</b>	<b>Port Connections</b>	<b>7</b>
<b>7</b>	<b>Panel Buttons</b>	<b>10</b>
<b>8</b>	<b>Remote Control</b>	<b>11</b>
<b>9</b>	<b>Basic Operations</b>	<b>12</b>
<b>9.1</b>	<b>Startup/shutdown</b>	<b>12</b>
<b>9.2</b>	<b>Sidebar Menu</b>	<b>12</b>
<b>9.3</b>	<b>Signal Source Switching</b>	<b>12</b>
<b>9.4</b>	<b>Signal Source Settings</b>	<b>13</b>
<b>9.5</b>	<b>Image Mode</b>	<b>14</b>
<b>9.6</b>	<b>Voice Mode</b>	<b>14</b>
<b>9.7</b>	<b>Menu Settings</b>	<b>15</b>
<b>9.8</b>	<b>Network Settings</b>	<b>15</b>
<b>9.9</b>	<b>Date and Language Settings</b>	<b>16</b>
<b>9.10</b>	<b>System Settings and Applications</b>	<b>17</b>
<b>9.11</b>	<b>Control Lock and Centralised Control Settings</b>	<b>18</b>
<b>9.12</b>	<b>Power On/off Setting</b>	<b>18</b>
<b>9.13</b>	<b>Comments</b>	<b>19</b>
<b>9.14</b>	<b>Android Homepage</b>	<b>19</b>
<b>9.15</b>	<b>Writing Software</b>	<b>20</b>
<b>9.16</b>	<b>Documents Manager</b>	<b>20</b>
<b>9.17</b>	<b>Quick Operation</b>	<b>21</b>
<b>10</b>	<b>Technical Parameters</b>	<b>22</b>
<b>11</b>	<b>Troubleshooting</b>	<b>23</b>
<b>12</b>	<b>Important Statement of Network Service</b>	<b>24</b>
<b>13</b>	<b>Toxic/Hazardous Substances/Elements in the Product</b>	<b>25</b>

# 1 Safety Warnings

1. Use only the power supply and voltage indicated on the label.
2. A three-prong power cord is included. Confirm that the ground terminal of the wall outlet is well grounded before installation. Route the power cord away from passageways to avoid stepping on it; also keep away from areas where the power cord may get crushed.
3. Do not overload the power outlet; use a certified power outlet.
4. In case of thunderstorms, please pull out the power plug and the network cable, and disconnect the product from the antenna to avoid damage.
5. If it is to be left unused for a long period of time, please power off the product and pull out the power plug.
6. In case of any abnormal sound or smell, please power off the product immediately and pull out the power plug. If necessary, stop using it and contact CommbOX Support as soon as possible.
7. Keep the product away from flammable and explosive materials (e.g., candle, electric stove, bulb).
8. Be careful to prevent any liquid or metal objects from entering into the product; otherwise, stop using it immediately and contact CommbOX Support.
9. When the product is moved from a low-temperature environment to a warm area, condensate may form inside it. In such case, the product should be placed still for at least 24h prior to restart to air-dry the condensate.
10. Handle the product with at least two persons; avoid impact and pay special attention to the display screen during the transfer.
11. To avoid injury, please install the base according to the instructions, and then place the product on an even and steady ground; or, if the base is not installed, the product should be firmly fixed to a wall according to the Wall Mount Bracket Installation Instructions.
12. Do not place the product in any environment with:
  - direct sunlight, moisture, high/low temperature, or dust.
  - poor ventilation or an enclosed environment.
  - any flammable or explosive material.
  - any combustible or corrosive gas.
13. In order to avoid the risk of explosion, do not expose the batteries to sunlight, fire or high temperature.

# 2 Precautions

- Do not attempt to disassemble/assemble this product as you may get exposed to dangerous voltage or other hazards. If necessary, please contact CommbOX Support.



- If the product is dirty, first disconnect the power plug, then dampen a cloth with water and wipe it with the damp cloth. Do not apply force while wiping the display screen as it may scratch the screen. Do not wipe with such solvents as alcohol, gasoline, acid, alkali, detergent, volatile oil and diluents since these solvents may damage the product.
- Condensate may appear inside the screen in high humidity, and this is a normal phenomenon as generally temperature difference between the external and internal glass surfaces may lead to formation of water droplets on the internal glass surface. Such water droplets will disappear automatically after 24h of normal use. Please rest assured to use the product.
- Do not insert any sharp or metal object into the vent or touch the signal connector with any sharp or metal object; otherwise short circuit or electric shock can be caused.
- Do not exert pressure on the LCD screen as it is made of glass.
- Do not place the product on an unsteady trolley, shelf or table; otherwise it may turn over. Move the product carefully when it is on a trolley. Emergency stop, excessive force or uneven ground can result in tipping over of the trolley and the product.
- Openings on the product are designed for heat dissipation to ensure good performance. Vent holes should not be covered with objects such as newspaper, tablecloth or curtain as they may impede ventilation.
- Do not allow a still picture or an active picture containing stationary text or icon to remain on the screen for too long because this will leave a “ghost image” on the screen, which will not disappear long after shutdown.

## 3 Product Features

This product uses HD LED-backlit panel, IR and multi-touch technologies. Equipped with a writing software, it is convenient, highly interactive, safe and environmentally friendly.

### High interconnectivity (optional)

This product can connect to other devices. It allows wireless connection with PCs, PADs and mobile phones, enabling wireless transmission of documents, wireless streaming of videos and wireless screen cast.

### Extraordinary Display

This product uses a high-quality HD LCD panel featuring original display colour, vivid pictures, uniform display, no flickering, and quick response. You can enjoy HD pictures from different angles.

### Accurate Touch Control

This product incorporates advanced touch technology featuring quick response, high positioning accuracy, strong environmental adaptability, accurate operation, etc. No stylus is needed; you can operate it with your hands by clicking, dragging and other actions.

### Highly Interactive

This product is preinstalled with a professional writing software. It provides multiple types of pens, drawing tools and other functions so you can write and move the contents as you like.

## 4 Accessories

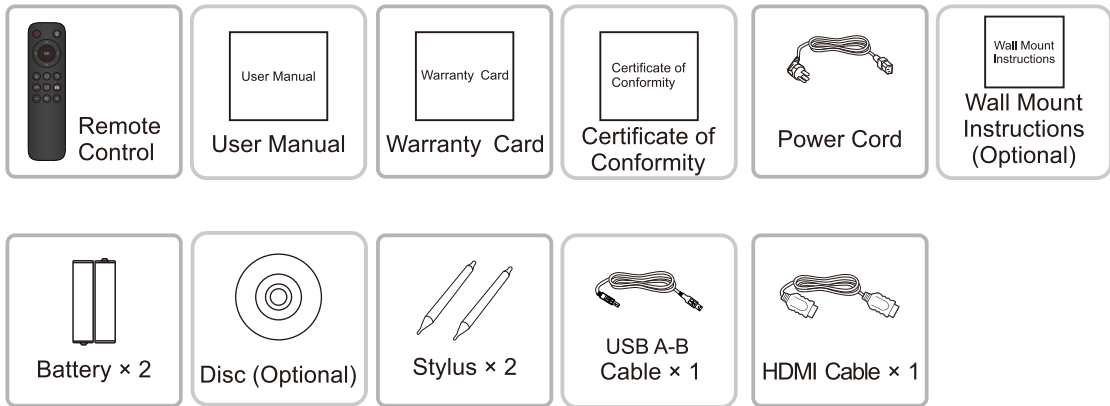

## 5 Wall Mount

### Installation Precautions

- For installation of the wall-mount bracket, at least two professional installers are required; you should not attempt to install it, otherwise injury may result.
- During installation, assistance from professional installers is needed to designate the installation location; measurements should be taken to ensure it can bear the required amount of external force. Make sure the bracket is installed onto a firm wall rather than plaster board or other surface which cannot provide adequate support.
- This product should be installed on the vertical plane, not on an oblique plane; also, it should not be installed with the front facing upwards; otherwise the product may fall or personal injury may be caused.
- To avoid injury or damaging the product, keep the bracket out of the reach of children.
- Tighten the screws during installation to avoid product damage and injury.
- The installation is shown in the figure below; ventilation space should be kept around the product.

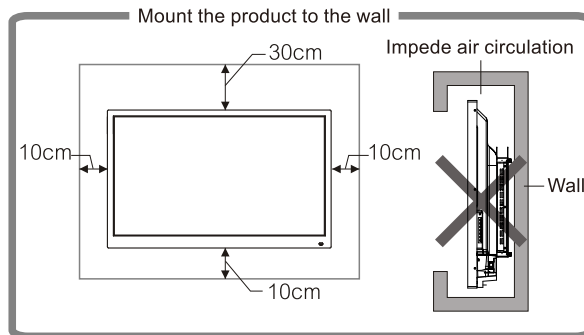

**For specific installation steps, please see the 55-75"/75-98" Wall Mount Installation Instructions.**

# 6 Port Connections

Note: The port connection instructions are provided below. The listed port types are for reference only, and do not cover all ports on this product.

## 6.1 Power Port



## 6.2 Signal Input Ports

### 6.2.1 USB port

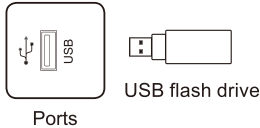

Note: The output current of USB2.0 port is 500mA, and that of USB3.0 port is 900mA. In order to ensure normal operation, please do not simultaneously use all USB ports to charge external devices.

Media USB port is used to connect external devices to the Android system of the product, which enables data reading via the File Manager of this product. PC USB port is used to connect OPS equipment. PUBLIC-USB port serves as both Media USB port and PC USB port, and is automatically switchable with the signal source.

Wireless keyboard and mouse can be connected to this product. In case of slow or no response, change the wireless receiver to another USB port, or use the USB extension cable to connect the wireless receiver to increase the reception range.

Some nonstandard USB devices may be unrecognizable, please use standard USB devices.

For upgrading software with a flash drive, please use a USB2.0 flash drive.

### 6.2.2 HDMI-IN port

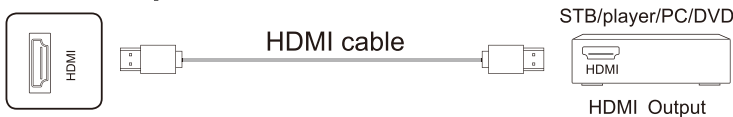

Note: The maximum resolution supported by HDMI port is 4K@60HZ, please see the section on Technical Parameters for the detailed signal formats. When 4K@60HZ signals are played, the EDID version in the OSD menu should be switched to EDID2.0.

### 6.2.3 TOUCH port



Note: For signal formats supported by the VGA port, see the Technical Parameters.

### 6.2.4 VGA audio/video port

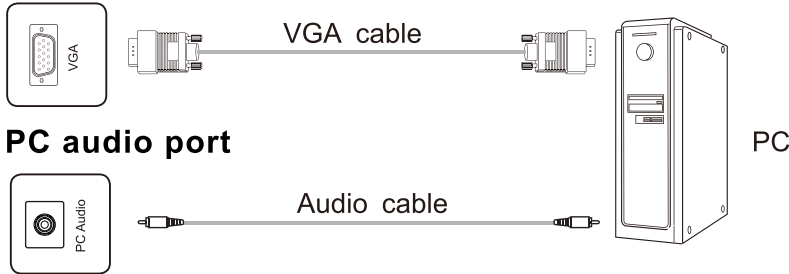

### 6.2.5 PC audio port

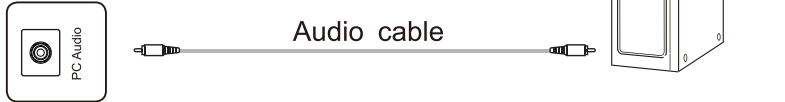

Note: For signal formats supported by the VGA port, see the Technical Parameters.

### 6.2.6 DP port

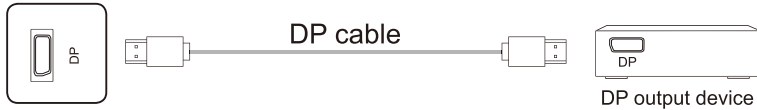

Note: The maximum resolution supported by DP port is 4K@60HZ. The signal quality depends on the length and quality of the DP cable, so please use the recommended cables or those of the trusted brands.

### 6.2.7 AV-IN port

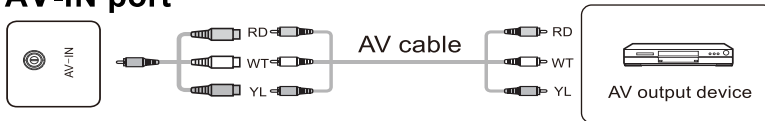

Note: The type of AV-IN port is  $\Phi 3.5\text{mm}$  MINI port. For connecting signals, a MINI adapter cable or a MINI adapter and an AV cable are required and connected as indicated by the figure.

### 6.2.8 YPBPR port

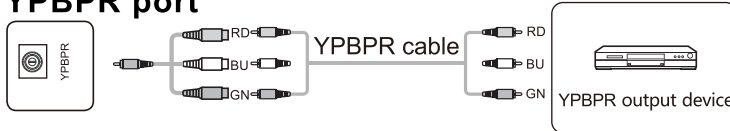

Note: The type of YPBPR port is  $\Phi 3.5\text{mm}$  MINI port. For connecting signals, a MINI adapter cable and a YPBPR cable are required.

### 6.2.9 TV port

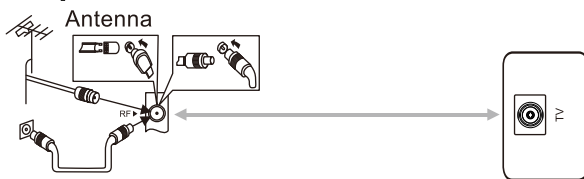

Warning: To connect an outdoor antenna to the signal port on this product, please first power off the product. The outdoor antenna should not be close to wires of high-voltage mains supply, otherwise electric shock may result.

## 6.3 Signal Output Ports

### 6.3.1 AV-OUT port

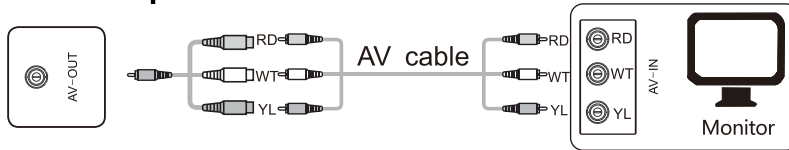

Note: The type of AV-OUT port is  $\Phi$ 3.5mm MINI port. For outputting signals, a MINI adapter cable and an AV cable are required; for connecting signals, a MINI adapter is required and connected as indicated by the figure.

### 6.3.2 HDMI-OUT port

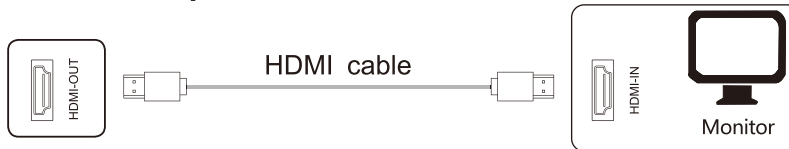

Note: The HDMI-OUT port can output Audio&Video signals to the HDMI-IN port of the second product, the second product can relay the Audio&Video signals to the third product, and so on. The maximum relaying amount depends on the quality and length of the HDMI cable. It is recommended to use the cables provided.

## 6.4 Audio Ports

### 6.4.1 Optical fibre ports

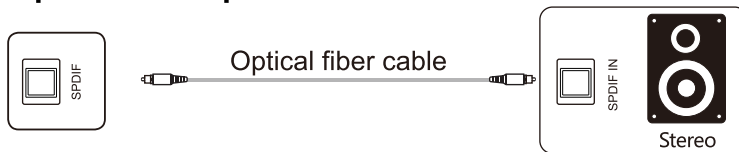

Note: This port can output audio signals of this product to speakers with a SPDIF-IN port.

### 6.4.2 Audio-OUT port



Note: Audio-OUT port can be connected with a headset or an external speaker.

## 6.5 Control Ports

### 6.5.1 RS232 port



# 7 Panel Buttons

## Interactive Classic 98

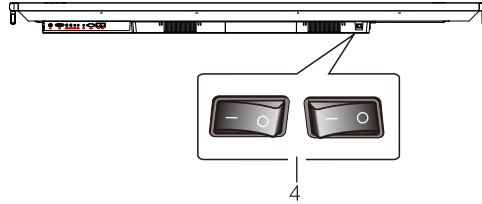
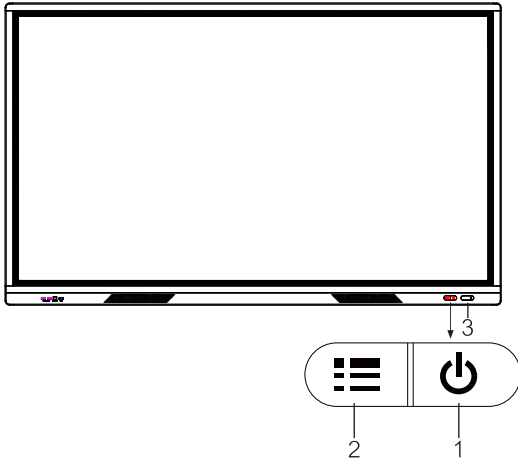

1. Power/standby button;
2. ON/OFF gesture button;
3. Indicator light, remote control receiver and light sensing receiver;
4. Power switch (“I” end is ON, “O” end is OFF. This switch is optional and subject to the actual product).

**Note: The appearance may vary with the model, and is subject to the actual product.**

## Interactive Classic 55-86

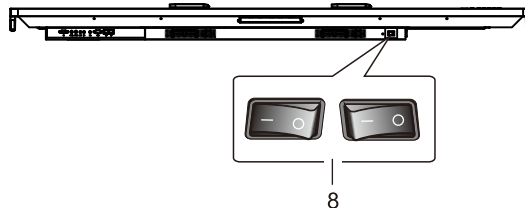
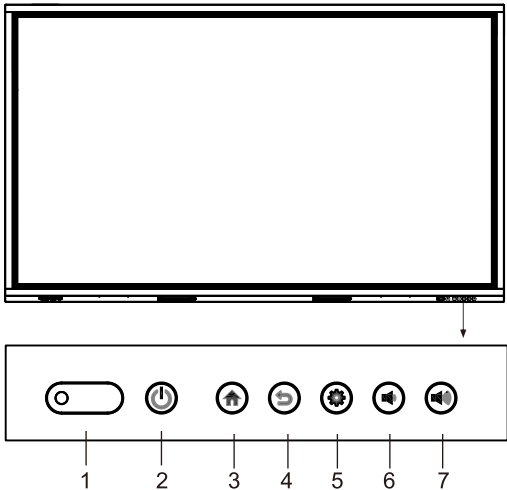

1. Indicator light, remote control receiver and light sensing receiver;
2. Power;
3. Homepage;
4. Back and touch unlock;
5. Setting;
6. Vol-;
7. Vol+;
8. Power switch.

## 8 Remote Control









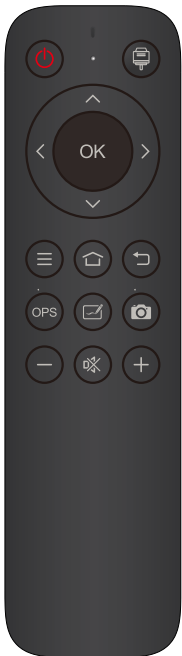

### Precautions for Use of the Remote Control

- Aim the remote control at the remote receiver when using the remote control. Any object placed between the remote control and the remote receiver may disturb the operation.
- Protect the remote control from vibration. Do not expose the remote control to direct sunlight as heat may deform it.
- When the remote receiver is subject to direct sunlight or strong light, the remote control may malfunction. In such case, please change the angle of lighting or the position of the product, or operate the remote control closer to the remote receiver.
- Replace the batteries in case of low battery, which reduces the range of the remote control. If the remote control is to be left unused for a long period of time or the batteries are depleted, please remove the batteries as battery leakage may damage the remote control.
- Do not use batteries of different types or mix a new battery with a used one. Always replace batteries in pairs.
- Do not throw batteries into the fire or recharge or disassemble batteries. Do not recharge, short-circuit, disassemble/assemble, heat or burn any used batteries. Please dispose of waste batteries according to the applicable environmental regulations. Do not expose batteries to any hot environment like direct sunlight or fire.

### Keys on the Remote Control

Type A Remote Control



KEY	Function
POWER (  )	Switch between Power-on and Standby states
SOURCE (  )	Open / close the Signal Source list
NAVIGATION KEYS (  )	Select or adjust menu options
OK ( OK )	Confirm the operation
MENU (  )	Show/hide the Main Menu
HOME (  )	Display the Android Homepage
BACK (  )	Return to the previous interface
OPS	Switch to OPS source
WRITING PAGE (  )	Switch to the writing page
SNAPSHOT (  )	Take a screenshot
VOL - (  )	Decrease the volume
MUTE (  )	Enable/disable sound
VOL + (  )	Increase the volume

1. The picture is for reference only, subject to the actual remote control.
2. Functions of the keys on the remote control may vary, subject to the actual functions.

## 9 Basic Operations

### 9.1 Startup/shutdown

#### 9.1.1 Startup/shutdown

Use 100-240V AC as the power supply.

⏻ on the panel and the remote control can be used to switch between Power-on and Standby states.

⏻ on the rear panel has two ends. Press the O end to power off the product; press the I end to power it on.

#### 9.1.2 Auto standby

In the Android main interface, regardless of whether there is a signal input or not, the product will not enter the Standby mode.

In the non-Android main interface, if there is no signal input for 15min, the product will automatically enter the Standby mode.

#### 9.1.3 Save before shutdown

Before shutdown, the product will save the image and sound settings. Upon restart, these settings will be used.

#### 9.1.4 OPS ON/OFF

If the product is installed with the OPS module and it is set to the OPS signal source, the OPS module will start automatically. If not, start it manually.

Before turning off the product, first use the touch function or mouse to turn off the OPS module from the Start menu. The Standby key on the panel or remote control can be used to turn off the product only after the OPS module completely shuts down. Do not press the Standby key or directly disconnect the power supply without turning off the OPS module as it will damage the OPS module.

When the OPS module enters the OFF state and no operation is performed on the PC for a long period of time, this product will enter the Standby mode. To use the module, just restart the product.

**Note: The OPS module is optional.**

### 9.2 Sidebar Menu

Select the Sidebar shortcut key arrow, or swipe inwards from the edge of the screen (when the touch signal switch is turned off) to display the Sidebar Menu, which includes the Settings Menu, Signal Source Menu, Small Tools, Progress Management, Android Homepage, Back and Comments.

### 9.3 Signal Source Switching

You can use the remote control or touch function to switch the input source by the following methods:

Method one: press the “Source” key on the remote control to open the Signal Source Menu, press the navigation keys on the remote control to select an input signal source, press the “OK” key, and the product will then switch to the input signal source you selected.



Method two: select the Sidebar Menu, select the Signal Source Menu, select the input signal source, and the product will then switch to the input signal source you selected.

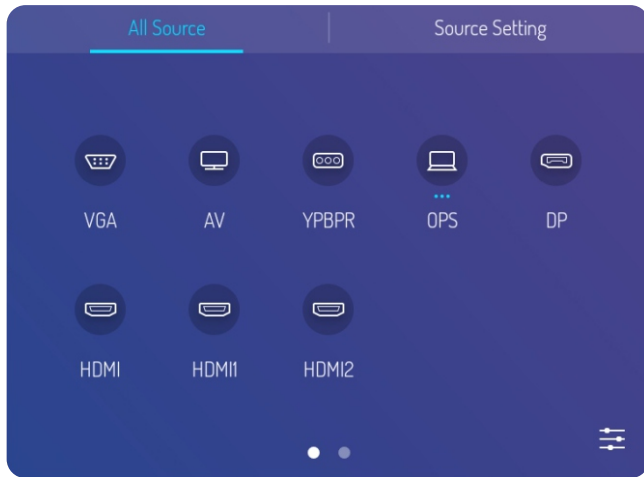

Note: the picture is for reference only, subject to the actual Signal Source Menu.

## 9.4 Signal Source Settings

In the Signal Source Menu, select the right-hand tab to enter the Signal Source Settings submenu to set the source auto-switching, lock, power-on and automatic power-off.

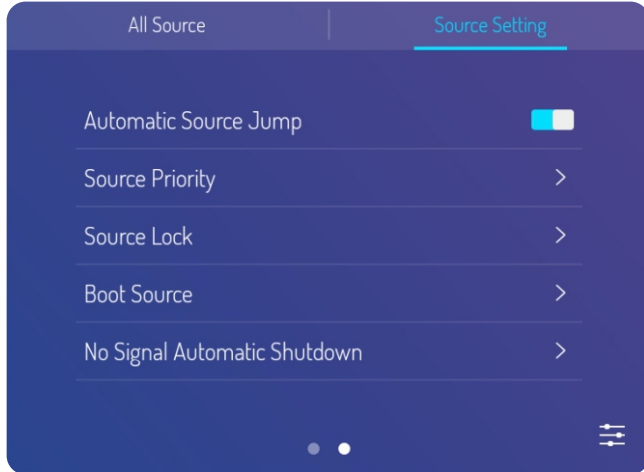

## 9.5 Image Mode

Select the Sidebar Menu, select the Signal Source Menu, and then select the menu icon in the bottom right corner of the Signal Source Menu to enter the submenu page and adjust the image mode, cool/warm tones, scaling patterns, as well as to toggle between different image modes.

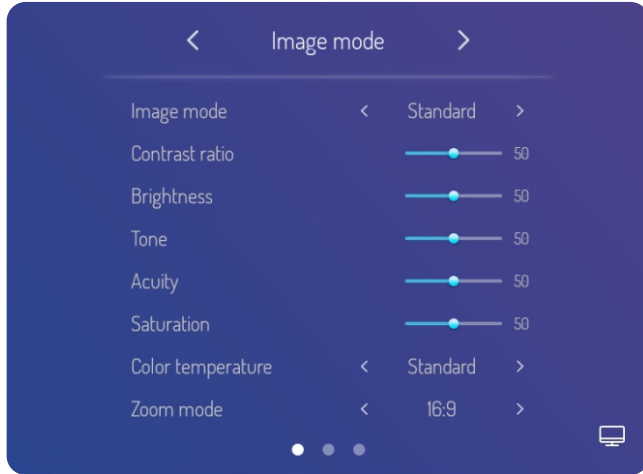

## 9.6 Voice Mode

Select the Sidebar Menu, select the Signal Source Menu, and then press the menu icon in the bottom right corner of the Signal Source Menu to enter the submenu page and adjust the volume, equalisation, bass and treble settings, as well as to toggle between different sound output devices.

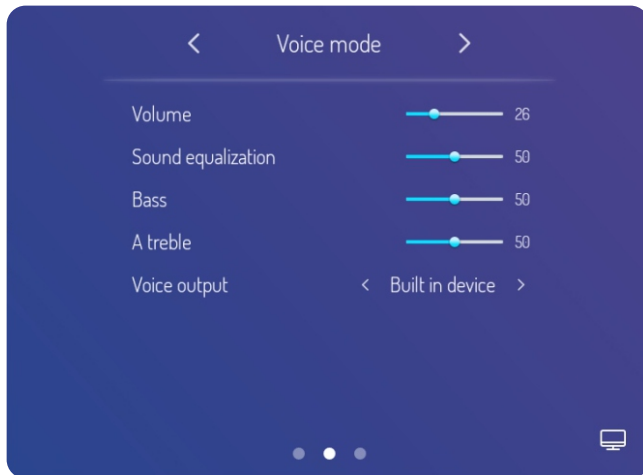

## 9.7 Menu Settings

Select the Sidebar Menu, select the Signal Source Menu and then select the menu icon in the bottom right corner of the Signal Source Menu to enter the submenu page and adjust the back light, auto-backlight, EDID version, HDR and HDMI output resolution settings.

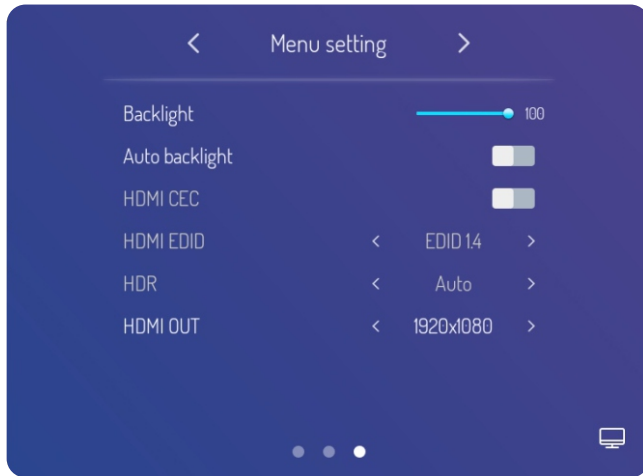

## 9.8 Network Settings

Select the Sidebar Menu and select the Settings Menu to enter the Network Settings page and set the wireless network, wired network and wireless hotspot.

### 9.8.1 Wireless network (optional)

1. Select the Sidebar Menu > System Menu > WLAN.
2. Turn on the Wifi switch.
3. Select a network to connect to from the Network List and enter the password to connect.
4. If there is no desired network in the Network List, manually add it.

### 9.8.2 Wired network

1. Connect one end of the network cable to the network port of this product before using the wired network, and then connect the other end to a router.
2. Select the Sidebar Menu > System Menu > Ethernet.
3. Turn on the Connect switch.
4. Select "DHCP" in IP settings, and the product will then automatically obtain an IP address and connect to the network.
5. Select "Static" in IP settings, manually input the IP address, gateway, network prefix length, DSN address, and then click "Save" to connect to the network.

Note: there are two network ports on this product, either of which can be connected to a wired network (choose one of them). When one network port is connected to a router, the other port can be connected to an external device. At this time, the Android system of this product, OPS (Windows system only) and the external device form a LAN, which can be connected to a network at the same time.

### 9.8.3 Wireless hotspot (optional)

1. Select the Sidebar Menu > System Menu > Hotspot.
2. Turn on the Hotspot Switch.
3. Enter the Hotspot name in the textbox. The default name is “Android AP-7654”, which can be changed.
4. Select encryption type. In case of an open network, no password is required, but any device that finds this network could connect to the WIFI network of this product. In case of the WPA PSK/WPA2 PSK security encryption, a password of over 8 digits shall be entered, and the correct password would be required for any other device to connect to the network.
5. After security encryption is selected, the system will automatically configure a password, or a new password can be entered in the password textbox.
6. Click “Enter” to save settings, and then the network could be found by other WIFI devices within range when they search for WIFI networks.

Note: please set a hotspot password of sufficient strength.

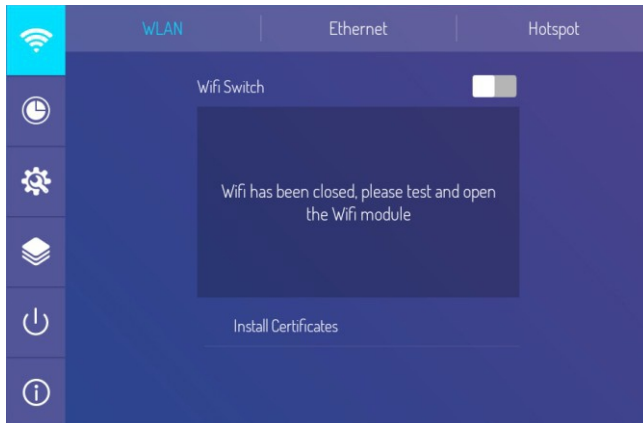

## 9.9 Date and Language Settings

Select the Sidebar Menu, select the Settings Menu and then select the Time and Date Menu to automatically synchronize and update the time through the network, as well as to set the 24hour setting, the date, time, zone, input method and system language settings in the respective submenus.

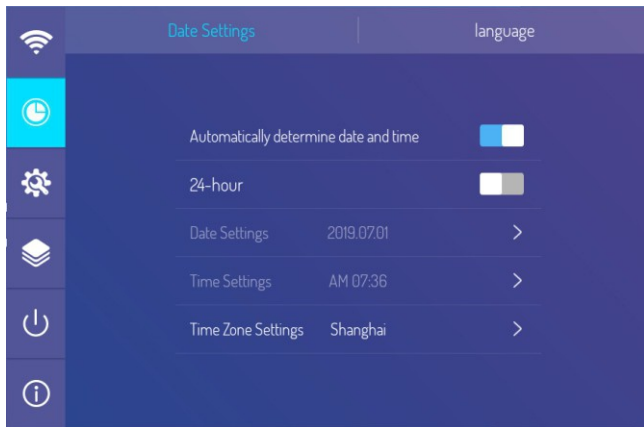

## 9.10 System Settings and Applications

Select the Sidebar Menu, select the System Menu and then select the System Settings Menu to set the wallpaper, screen-lock background, no signal image, count-down, password, start-up screen lock, factory data reset, automatic checking for updates, manual checking for updates and Android Apps management in the respective submenus.

Note:

1. The wallpaper and screen lock background images can be in PNG or JPEG formats, and suggested resolutions are 1920\*1080 and 3840\*2160. In order to import the file successfully, please do not import larger files.
2. The initial product password is 888888. If you change it, please remember the modified password. If the password is forgotten, please contact CommbOX Support for a super-password and reset the password.
3. Please do not arbitrarily restore the product to factory settings. If you encounter a malfunction, please reset the product to factory settings under the guidance of CommbOX Support.

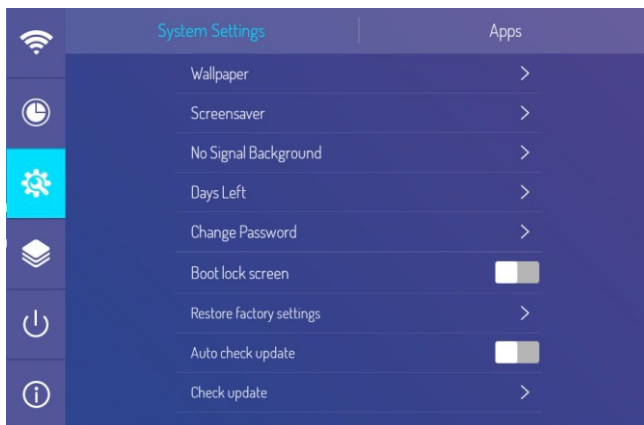

## 9.11 Control Lock and Centralised Control Settings

Select the Sidebar Menu, select the Settings Menu and then select the Control Settings page to set the remote control lock, touch lock, panel lock, smart screen refreshing, gestures and centralized control in the respective submenu.

Note:

1. Touch lock can only be removed via the Back key on the remote control or the panel.
2. The function of Smart Screen Refreshing is to prevent image retention due to a static frame being displayed for a long time, which may cause electric burning damage to the LCD.
3. Gesture switch sets the gestures that call the Sidebar Menu (swipe from the edge of the screen to the centre), Bottom-bar Menu (swipe up from the bottom-left of the screen), and the Floating Loop Menu (which can be dismissed with a three-finger touch).

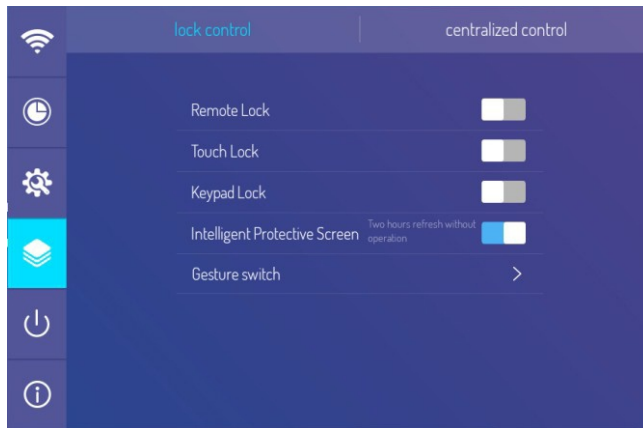

## 9.12 Power On/off Setting

Select the Sidebar Menu, select the Settings Menu and then select the Power Menu to set the Wake On LAN, timer, start and power-off times in the respective submenu.

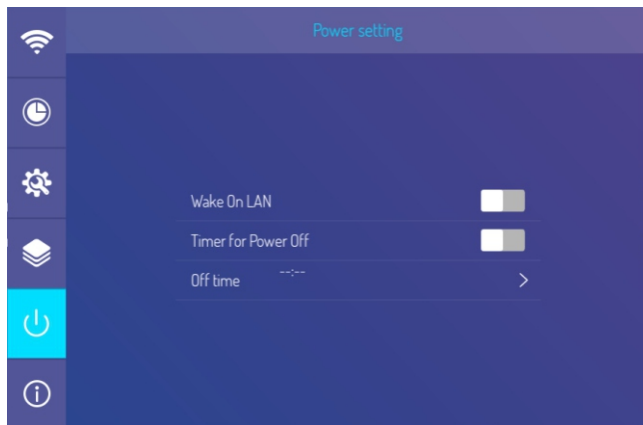

## 9.13 Comments

Select the Sidebar Menu and select the Comments icon to annotate the current page.

Note: The homepage background and icons are subject to the actual product.



## 9.14 Android Homepage

Android Homepage displays the time, date, flash drive information, network information, hotspot information and shortcuts for the Whiteboard and the Documents Manager, while the All Apps shortcut leads to the system apps and third-party apps.

Note: The homepage background and icons are subject to the actual product.

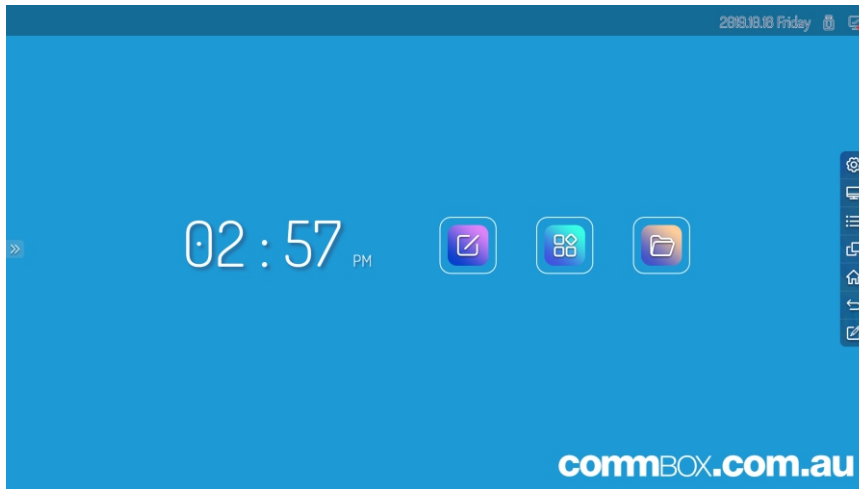

Note: User can install new applications and the operation of the product may vary accordingly. The operation methods detailed in this Manual are for reference only. User shall operate the product according to the actual situation.

## 9.15 Writing Software

The electronic Whiteboard writing software contains the Selection, Background Settings, Brush Settings, Undo, Restore, Text, Clear Screen, Save, Import Picture, Spot Light, Split Screen and other functions.

(Note: The writing software function changes dependent on the use and is subject to the actual product.)

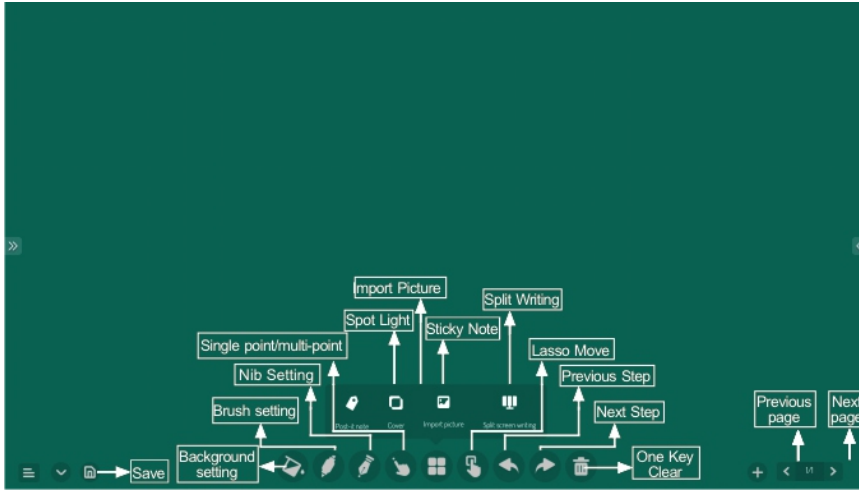

## 9.16 Documents Manager

The Documents Manager supports the playing of images, videos, audio, etc. Long-pressing allows moving, copying, or deleting the selected document.

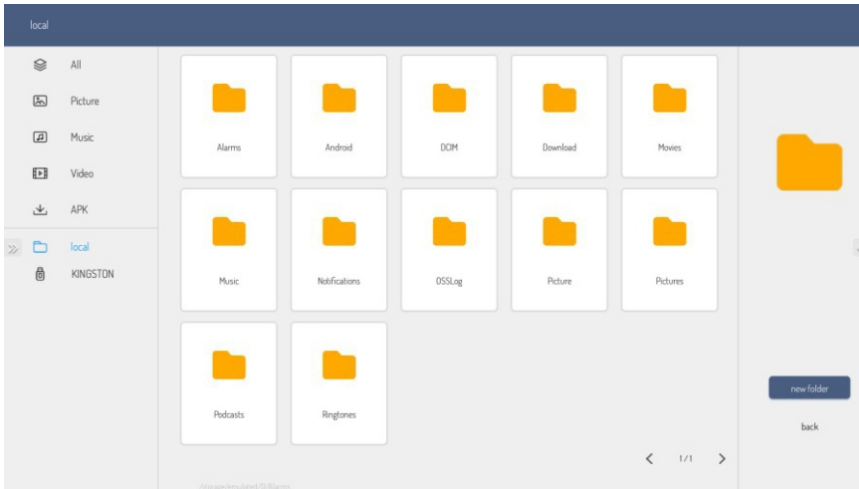



## 9.17 Quick Operation

Long-press with two fingers to open the Popup Loop Menu. Swiping up from the edge of the bottom left corner of the screen opens the Bottom-bar Menu, which includes the Help and Popup Loop Menus. Click the Help icon to view the Operation Guide; click on the Popup Loop Menu icon for quick shortcuts.

(Note: The Homepage background and icons are subject to the actual product.)

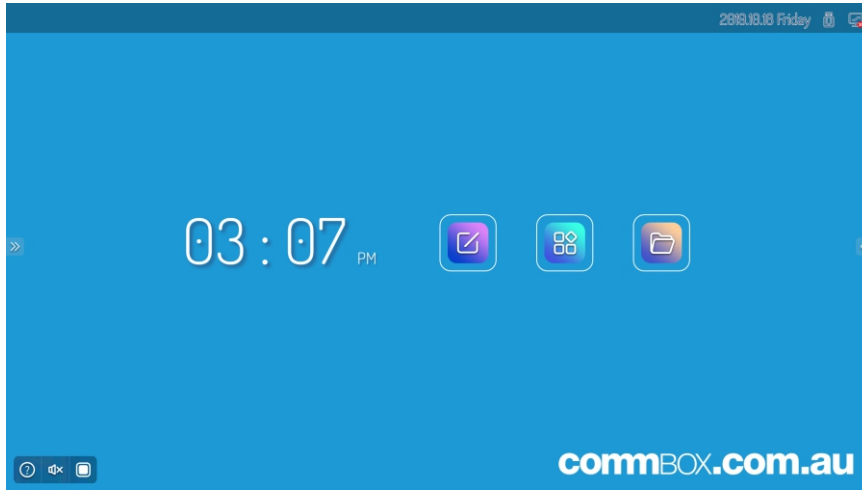

## 10 Technical Parameters

### Mode Display VGA

NO.	Mode	Resolution	Refresh Rate
1	VGA	640X480	60Hz
2	SVGA	800X600	60Hz
3	XGA	1024X768	60Hz
4	WXGA	1360X768	60Hz
5	WUXGA	1920X1080	60Hz

### Mode Display HDMI

NO.	Mode	Resolution	Refresh Rate
1	SD	720X480	70Hz
2		720X576	50Hz
3		1280X720	50Hz
4		1280X720	60Hz
5	HD	1920X1080	50Hz
6		1920X1080	60Hz
7	UD	3840X2160	30Hz
8		3840X2160	60Hz

# 11 Troubleshooting

**Note:**

Before requesting product maintenance, please check the following table for possible reasons for the problem encountered. If the problem persists, please contact Commbox Support to request product maintenance.

Problem	Possible Reason	Solution
The screen does not display anything; there is no sound, and the indicator does not come on	The power cord is not plugged in properly, power connection failure	Check if the power cord is properly connected
Pictures shown on the product have a dotted line or striped interference	Signal interference caused by automobile, neon light, electric hairdryer, etc.	Try to find the device that affects the product, and move it away from the product, or insert the power plug into another socket
Pictures shown on the PC are offset, do not cover the entire screen, go beyond the screen, or are blurred	1.Improper adjustment 2.Wrong display mode	1.Use the auto adjustment function 2.Enter "PC Screen Adjustment" to adjust the horizontal or vertical position 3.Use the recommended mode
Short remote control distance, malfunction of the remote control	1.The remote receiver of the product is blocked by some other object 2.Battery level of the remote control is low	1.Move the object to avoid blocking the remote receiver 2.Replace the battery
The product freezes, crashes or cannot be operated	1.Too many programs are running 2.Normal operation of the product is disturbed by the environment (e.g., lightning, static electricity)	Disconnect the product from power supply; wait for 1-2min and reconnect power supply; then restart the product
The touch-response is slow, it doesn't work	Too many programs are running	Close the program that is using up the memory or restart the product
OPS can't be turned on, no display, no touch	OPS has not been installed properly	Reinstall the OPS computer
Touch excursion	Computer's coordinate system requires correction	Enter the control panel to select the correction processing
Invalid touch on the external computer	1.The signal source is inconsistent with the corresponding interface of the TOUCH-USB cable 2.The TOUCH-USB cable is too long or of low quality	1.Check and change the corresponding interface of the TOUCH-USB cable, 2.Change to another shorter or better quality TOUCH-USB cable.

## 12 Important Statement of Network Service

All contents and services obtained through the product are owned by third parties and protected by copyright, patent, trademark and/or other intellectual property laws.

These contents and services are only for your personal non-commercial purposes, which shall not be used in a way not authorized by the content owner or service provider.

Under no circumstance shall our Company be liable for any direct, indirect or unexpected losses or damages arising from your or any third party's access to any contents or services or any information or third-party software through this product.

Third-party services may be subject to change, removal or discontinuation without prior notice. Our Company does not represent or warrant that some services or contents will remain accessible at any time.

Our Company will not be responsible for any service related to these contents and services, or assume any liability for customer service. For any question or service request about these contents and services, please directly contact the corresponding content or service provider.

## 13 Toxic/Hazardous Substances/Elements in the Product

Component	Toxic and Hazardous Substance or Element					
	(Pb)	(Hg)	(Cd)	(Cr <sup>6+</sup> )	(PBB)	(PBDE)
Display screen	X	O	O	O	O	O
Housing	O	O	O	O	O	O
PCBA*	X	O	O	O	O	O
Power cord and cables	X	O	O	O	O	O
Metal parts	O	O	O	O	O	O
Packing materials*	O	O	O	O	O	O
Remote control	X	O	O	O	O	O
Speaker	X	O	O	O	O	O
Accessories*	O	O	O	O	O	O

This table has been prepared in accordance with GB/T26572-2011.

- \* : PCBA includes the PCB and its electronic components;  
Packaging materials include the carton, EPS, etc;  
Other accessories include the User's Manual, etc.

O : The content of such toxic/hazardous substance in all homogeneous materials of such component are under the content limit specified in GB/T26572-2011.

X : The content of such toxic/hazardous substance in one or more homogeneous materials of such component goes beyond the content limit specified in GB/T26572-2011.

As shown in the above table prepared based on the data provided by our material suppliers for each type of materials and verified by us, this product contains hazardous substances. The hazardous substances contained in some materials are irreplaceable at the current technological level although we've been trying to make improvements.

The environment-friendly use period of this product is 10 years (see the pollution control symbol in the figure on the right).



Such use period will be maintained under the normal working conditions specified in the User's Manual only.

Indicative Description of Regulations on Recycling and Disposal of Waste Electrical and Electronic Products.

To care for and protect the Earth better, please send to a local manufacturer with nationally recognized qualification for recycling according to the applicable national laws and regulations on recycling of waste electrical and electronic products when you no longer need this product or at the end of its service life.



The terms HDMI and HDMI High-Definition Multimedia Interface, and the HDMI Logo are trademarks or registered trademarks of HDMI Licensing Administrator, Inc. in the United States and other countries.

# Notes

---

---

---

---

---

---

---

---

---

---

---

---

---

---

---

---

---

---

---

---

---

---

---

---

---

---

---

---

---

# Notes

---

---

---

---

---

---

---

---

---

---

---

---

---

---

---

---

---

---

---

---

---

---

---

---

---

---

---

**commBOX.com.au**

p: +61 2 9975 6001 | e: [office@commbox.com.au](mailto:office@commbox.com.au)